

# Light Panel

for walls & columns

-  Durable
-  Cost Effective
-  Time Saver
-  Safe



9001 - 14001 - 45001



Flexible



Easy to disassemble



Easy to install



Very Lite



# Light Panel

for walls & columns

[www.masterscaf.com](http://www.masterscaf.com)    

# WELCOME

# Light Panel

## Introduction

Light Panel System is an ideal panel formwork system for all sites .  
Either the walls and columns are changing continuously or they are always the same throughout the project it isn't important for Light Panel System .  
Light Panel System suitable for any type of project very succesfully . All components are designed to be man handled .  
If there is no crane at the side panels can be easily carried by hand .  
If there is an available crane then some panels are assembled to a big panel and are transferred by crane together .

## Light Panel Profile

Light Panel System profiles which form the frame increase the strenght of the panel & ensure along service life.

## System features

- All components are light enough to be carried by hand .
- System is designed to with stand against fresh concret pressure of 60 kN/m2 .
- All components are ready to use upon arrival at the site .
- By means of special shaped profiles and one blow clamps,panel connections are very easy & quick .
- Panel connection are not dependent on the holes of the frame profiles .
- The frame surrounds the plywood and protects plywood's edges from unwanted injuries .
- A few clamps are enough for a rigid connection .
- This ensures shorting the assembly and disassembly period .
- The frame prevents the water to get into the plywood through its sides .
- Through silcon at the surround the panel .



# Light Panel

## System Overview

### System overview

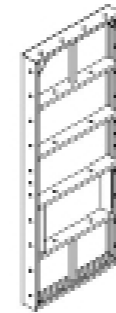

#### Light Panel

It is the main component of the system, the surface of the panel is covered by 15 mm thick film - coated plywood. specials profiles are used to form the frame .

#### Outside Panel

One of the outside corner solution is to use profex outside corner panel .

Description	Weight Kg
outside corner 120 cm	11.00
outside corner 150 cm	13.00
outside corner 300 cm	26.00



#### Tie rod & wing nut

Tie rods & wing nuts with stand the fresh concret pressure on the formwork.

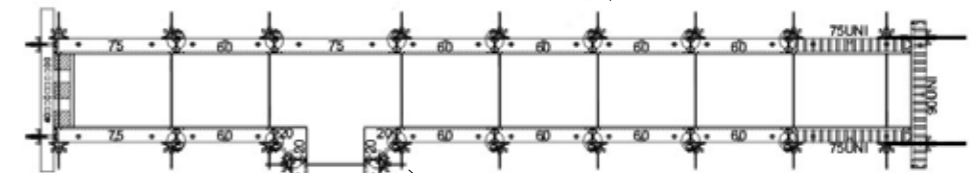

#### inside Panel

Whether the angle is obtuse,acute or right, there is always a convenient inside corner panel .

Description	Weight Kg
30 cm x 30 cm x 120 cm	26.80
30 cm x 30 cm x 150 cm	33.50
30 cm x 30 cm x 300 cm	67.10

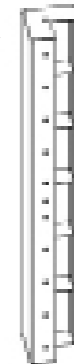

#### universal panel

Manar profex universal panels provide easy solutions at the columns, at the stop - ends and at the corners .

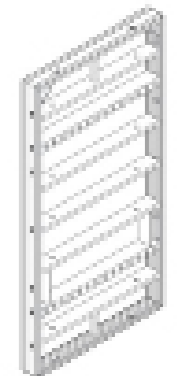

# Light Panel



## Standard Components

### Light Panel

Panels are manufactured in different heights ( 3.00 m, 1.50 m , 120 m ) and different widths ( 0.30 m, 0.45 m, 0.60 m, 0.75 m, 0.90 m ). specialshaped, strong profiles which form the frame increase the strength of panel & ensure a long service life . also by means of the frame profiles and the clamps , the connection is not dependent on the holes of the frame profiles.

#### Available size

Description	Weight Kg	Description	Weight Kg	Description	Weight Kg
30 cm x 120 cm	13.26	30 cm x 150 cm	16.57	30 cm x 300 cm	33.15
45 cm x 120 cm	19.89	45 cm x 150 cm	24.86	45 cm x 300 cm	49.73
60 cm x 120 cm	26.52	60 cm x 150 cm	33.15	60 cm x 300 cm	66.31
75 cm x 120 cm	33.15	75 cm x 150 cm	41.44	75 cm x 300 cm	82.89
90 cm x 120 cm	39.78	90 cm x 150 cm	49.73	90 cm x 300 cm	99.46

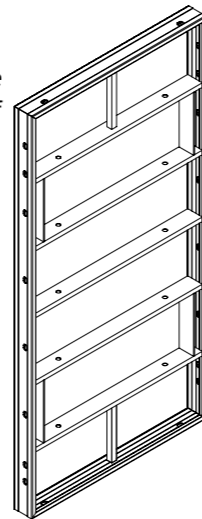

### Light Universal Panel

Universal panels are manufactured in different heights ( 3.00 m, 1.50 m , 120 m ) and different widths ( 0.30 m, 0.45 m, 0.60 m, 0.75 m, 0.90 m ). the feature of the universal panel is the multihole reinforcement which has holes with 5 cm intervals . thanks to the hole pattern , universal panels provide special solutions at the corners and the stop - ends.

#### Available size

Description	Weight Kg	Description	Weight Kg	Description	Weight Kg
30 cm x 120 cm	13.26	30 cm x 150 cm	16.57	30 cm x 300 cm	33.15
45 cm x 120 cm	19.89	45 cm x 150 cm	24.86	45 cm x 300 cm	49.73
60 cm x 120 cm	26.52	60 cm x 150 cm	33.15	60 cm x 300 cm	66.31
75 cm x 120 cm	33.15	75 cm x 150 cm	41.44	75 cm x 300 cm	82.89
90 cm x 120 cm	39.78	90 cm x 150 cm	49.73	90 cm x 300 cm	99.46

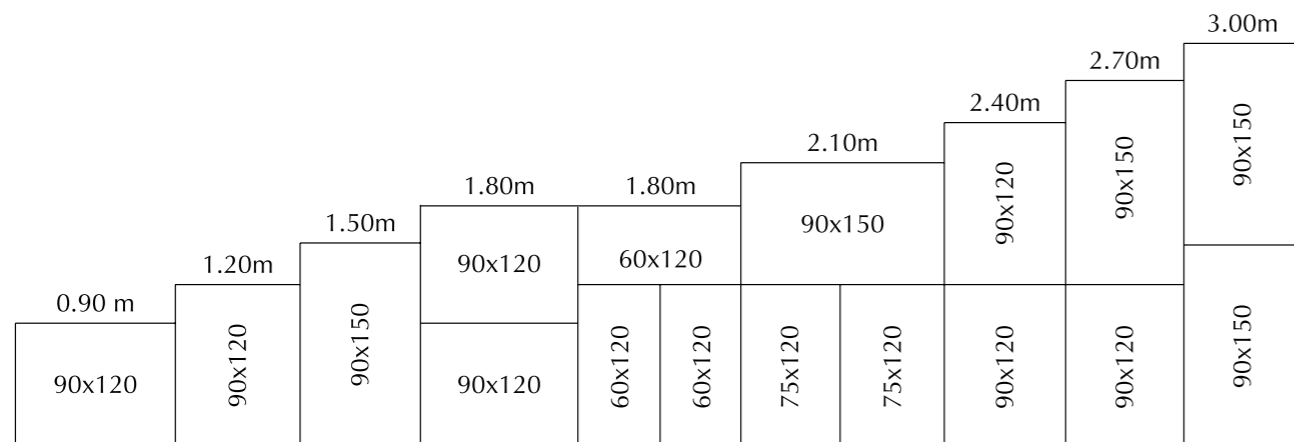
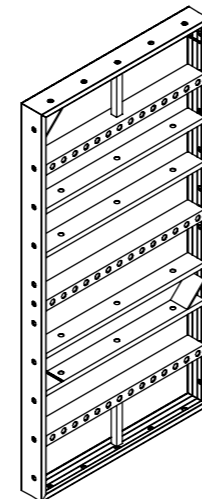

# Light Panel



## Standard Components

### Light Panel Clamp

Light panel clamps connect the panels easily . only one blow is enough to make a rigid connection. Clamps are not dependent on the holes of the frame profile. Due to special shape of the frame profiles the clamps connect two panels together at any point around the frame .

Step 1



Step 2



#### Required quantity of clamps for panels

	Panel size	Required clamps quantity
Align Vertical	30 - 45 cm	1 piece
	60 - 75 - 90 cm	2 pieces
Align Horizontal	120 cm	2 pieces
	150 cm	2 pieces
	270 - 300 cm	3 pieces

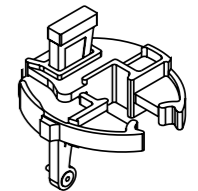

Description	Weight Kg
Clamp	1.50

### Adjustable Clamp VD

The space between two panels can be filled easily by means of adjustable clamp VD till 15 cm. so length adjustment is achieved precisely with standard panels & filling timbers .

Note for filler : Not more than 50 mm only adjustable clamb can be used with tie rod without universal waling .

For filler exceed 50 mm adjustable clamb will be used with tie rod & universal waling

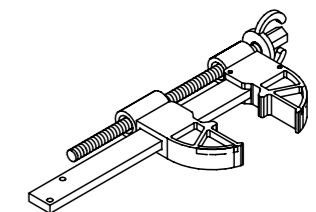

Description	Weight Kg
Universal clamp	4.00

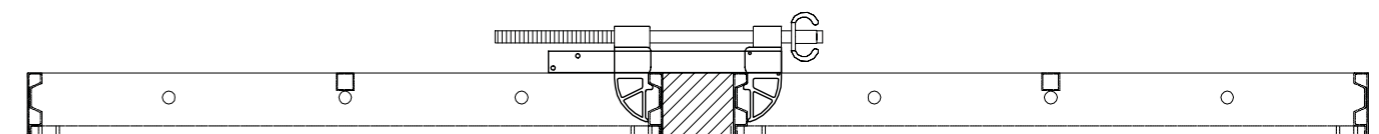

# Light Panel



## Standard Components

Stop-End detail Three different stop-end solutions are possible .

With stop-end solutions are possible

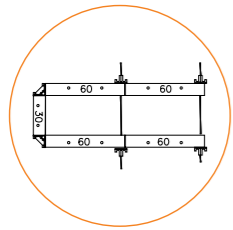

With universal panel

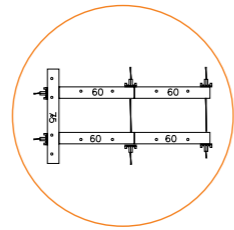

With universal waling

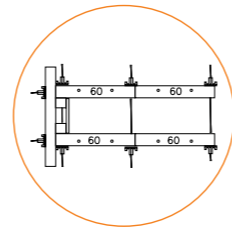

## Light Panel different Size

Same sizes panels can be used for different size column by means of universal panels. In this way same column formwork can be used for a whole Project in which different column sizes exist . This provides flexible use to the system .

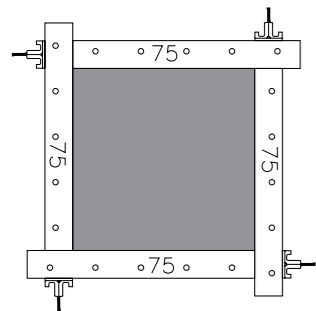

60 x 60 column

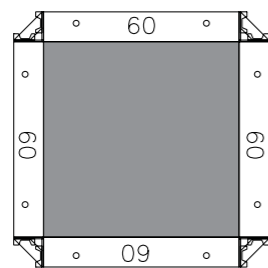

60 x 60 column



### In case of astaking columns

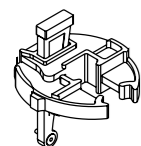

Panel size	Required clamps quantity
1.20	3 pieces
1.50	3 pieces
3.00	6 pieces

## Concrete Pressure

The max concrete pressure while using of universla panel for column is ( 60 kn / m )  
The max concrete pressure while using of standard panel for wall ( 40 kn / m )

# Light Panel



## Standard Components

### Lifting Bracket

lifting bracket is a safely lifting and moving (by crane) which actually results in a dramatically saving in both the time and effort. The allowable load for the lifting bracket is 750 KG/ Hook and maximum of 60o between lifting chains.

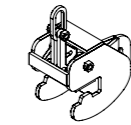

### Universal waling

In the case of connecting two panels with wooden filer .

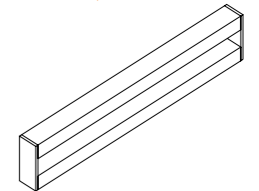

### Scaffold Bracket

Since safety during concreting is a must, the wide working Scaffold bracket enables for a safe and faster working environment with an allowable load of 150 KG/m2.

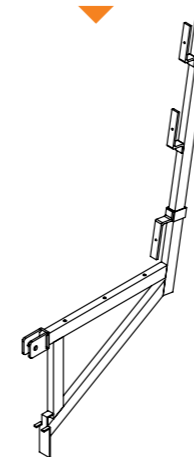

### Waling connector

Waling connector connects the panel to the universal waling

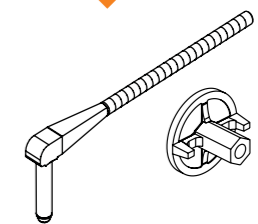

### Connection Head

used to connect push pull with light panel

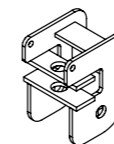

### Corner connector

corner connector use to connect 2 light panels perpendicular

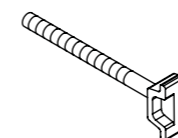

### Push Pull Prop

Description	Weight Kg		
∅ 1.5" Length ( 1.50 m - 2.00 m ) Length ( 2.00 m - 2.50 m )	} B 9.00 11.00		
		∅ 2.0" Length ( 3.00 m - 3.50 m ) Length ( 3.50 m - 4.00 m )	} A 17.00 19.00

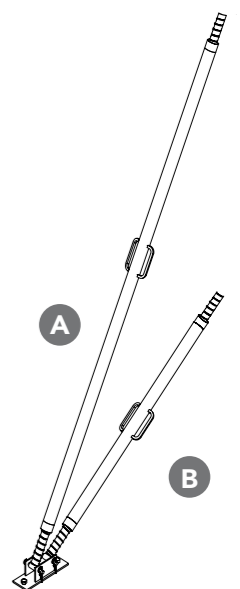

# Light Panel



## Light Panel Projects

Project Name : Aura Project CFC  
Contractor : CRC Dorra  
Owner : Al.Futtaim Group  
Year : 2020  
System Used : Light weight Panel for columns

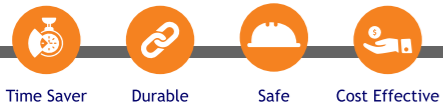

Time Saver Durable Safe Cost Effective



# Light Panel



## Light Panel Projects

Project Name : Latin Quarter Buildings  
Contractor : Redcon construction co.  
Year : 2019  
System Used : Light panels for columns



Time Saver Durable Safe Cost Effective



Version **2023**

Scaffolding Master for scaffolding & supplies

**MASTERSCAF**

Formwork

**Head Office**  
New Cairo Business Park - Building 25K

**Factory**  
Industrial Obour City Zone B,C No. 27001, cairo

**Email**  
[info@masterscaf.com](mailto:info@masterscaf.com)

**Website**  
[www.masterscaf.com](http://www.masterscaf.com)

    [www.masterscaf.com](http://www.masterscaf.com)